



*Exhibit Layout
Guide featuring*

STOWaway[®]
PAT.US 6,715,255 B2

Folding Truss System



800-457-2369 • 801-409-9036 fax

Miriam inc

Marketing Agency



800-457-2369 • 801-409-9036 fax

Miriam inc

Marketing Agency

Design-0035

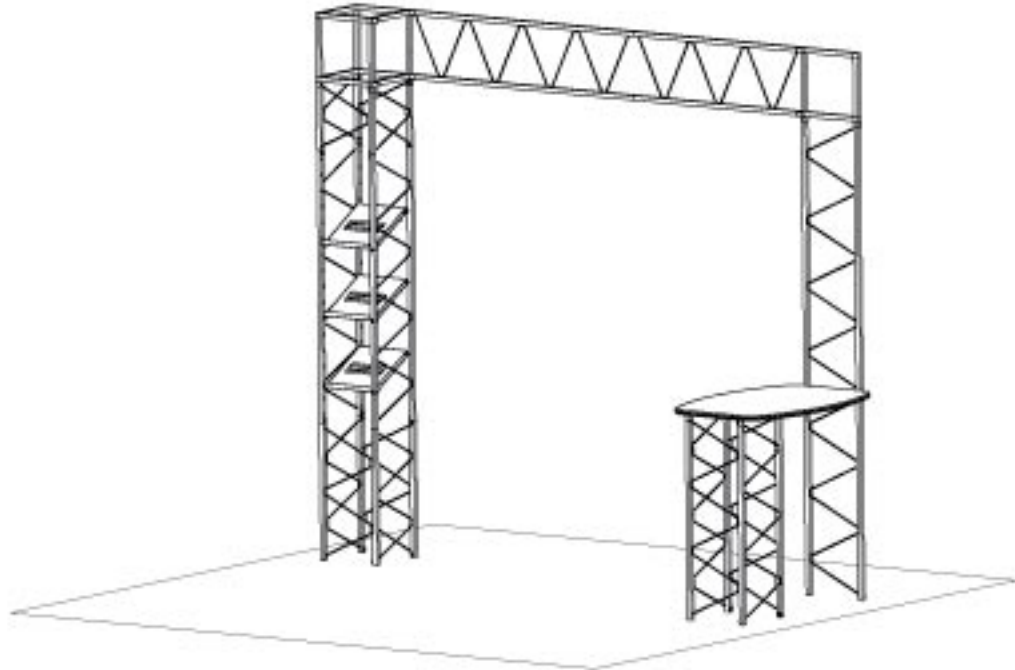

Booth Size: 10' x 10'

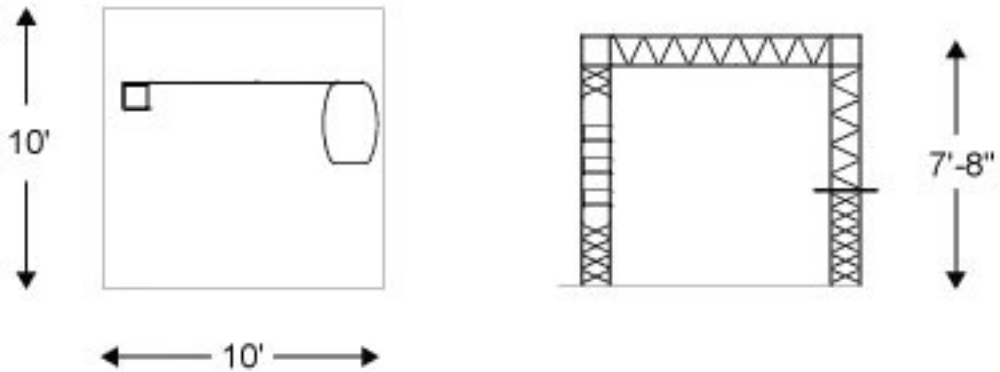

Design - 0035

Approx. Total Wt. = 125#

Shipping Class: 100

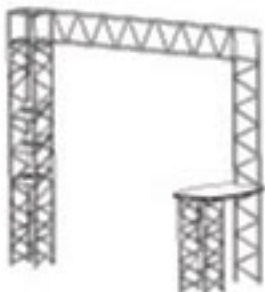

Quantity	Part Description	Part Number
1	STOWAWAY BOX STRAIGHT 11.5	SQA1
1	STOWAWAY BOX STRAIGHT 23	SQA2
1	STOWAWAY BOX STRAIGHT 34.5	SQA3
1	STOWAWAY BOX STRAIGHT 46 IN FOR SHELVES	SQA4A
1	STOWAWAY CUBE INT RIGID 90° 2 WAY	SQX1
2	STOWAWAY FLAT STRAIGHT 34.5	SFA3
2	STOWAWAY FLAT STRAIGHT 46	SFA4
1	STOWAWAY FLAT CUBE 90 1PLN 2 WAY	SFX1
3	STOWAWAY SHELF - RECESSED	SAU1
1	STOWAWAY COUNTER TOP KIT	SAU13
2	STOWAWAY ARM LIGHT	SAU31
2	STOWAWAY MOLDED SHIPPING CASE	SAU26



800-457-2369 • 801-409-9036 fax

Miriam inc

Marketing Agency

Design-0036

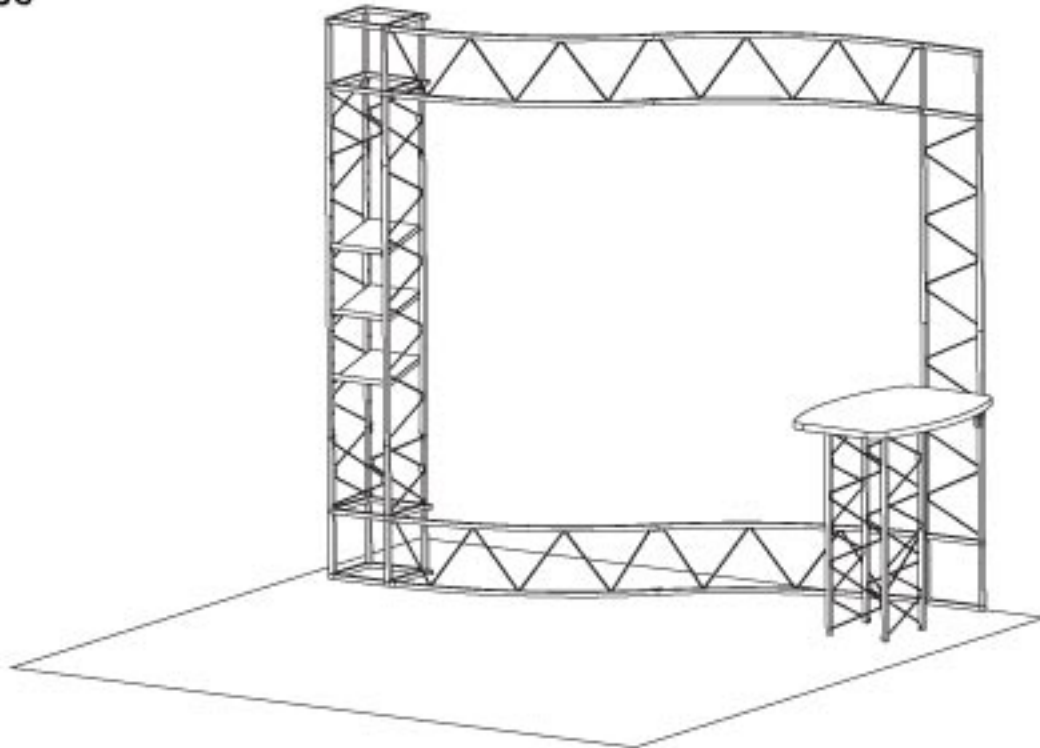

Booth Size: 10' x 10'

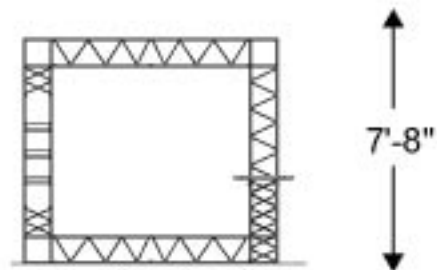
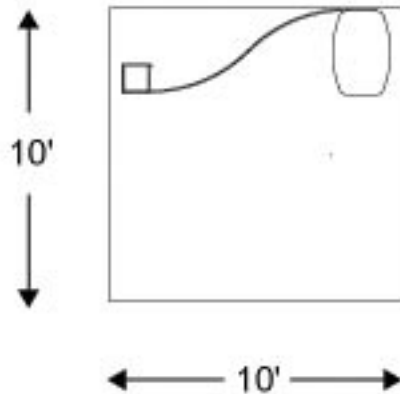

Design - 0036

Approx. Total Wt. = 130#

Shipping Class: 100

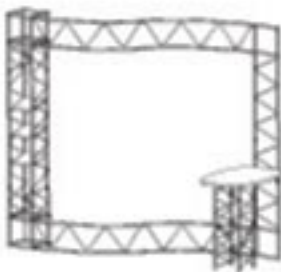

Quantity	Part Description	Part Number
2	STOWAWAY FLAT STRAIGHT 34.5	SFA3
4	STOWAWAY FLAT 45° CURVE	SFM2A
2	STOWAWAY FLAT INT RIG90° 1PL2W	SFX1
2	STOWAWAY BOX STRAIGHT 11.5	SQA1
1	STOWAWAY BOX STRAIGHT 34.5	SQA3
1	STOWAWAY BOX STR 46 FR SHELVES	SQA4A
2	STOWAWAY CUBE INT RIG 2WAY 90°	SQX1
3	STOWAWAY SHELF - RECESSED	SAU1
1	STOWAWAY COUNTER TOP KIT	SAU13
2	STOWAWAY ARM LIGHT	SAU31
1	STOWAWAY MOLDED SHIPPING CASE	SAU26



800-457-2369 • 801-409-9036 fax

Miriam inc

Marketing Agency

Design-0037

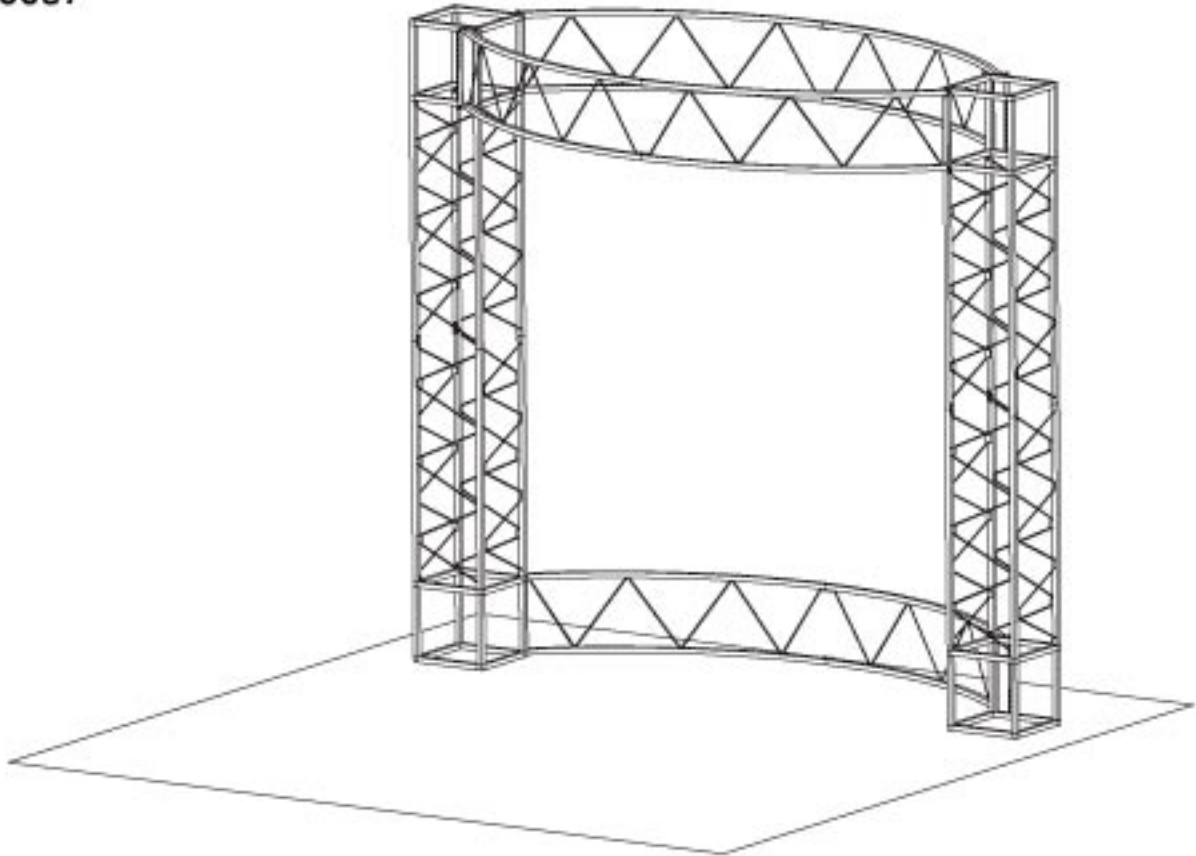

Booth Size: 10' x 10'

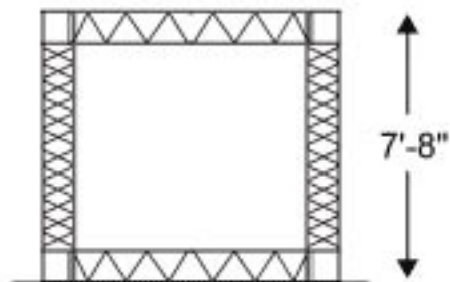
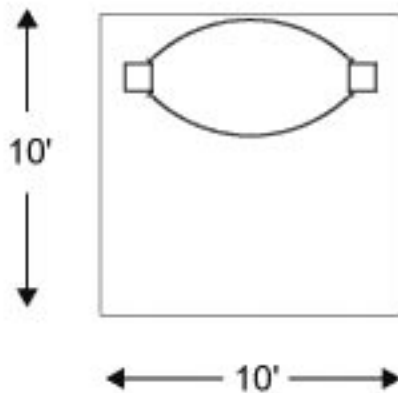

Design - 0037

Approx. Total Wt. = 145#

Shipping Class: 125

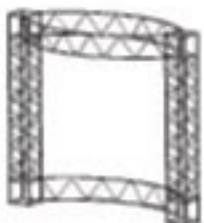

Quantity	Part Description	Part Number
4	STOWAWAY BOX STRAIGHT 34.5	SQA3
4	STOWAWAY CUBE INT RIGID 90° 2 WAY	SQX1
6	STOWAWAY FLAT CURVE 45° H	SFM2A
6	STOWAWAY PLATE 45° W/ HALF CON	41493
2	STOWAWAY ARM LIGHT	SAU31
2	STOWAWAY MOLDED SHIPPING CASE	SAU26



800-457-2369 • 801-409-9036 fax

Miriam inc

Marketing Agency

Design-0038

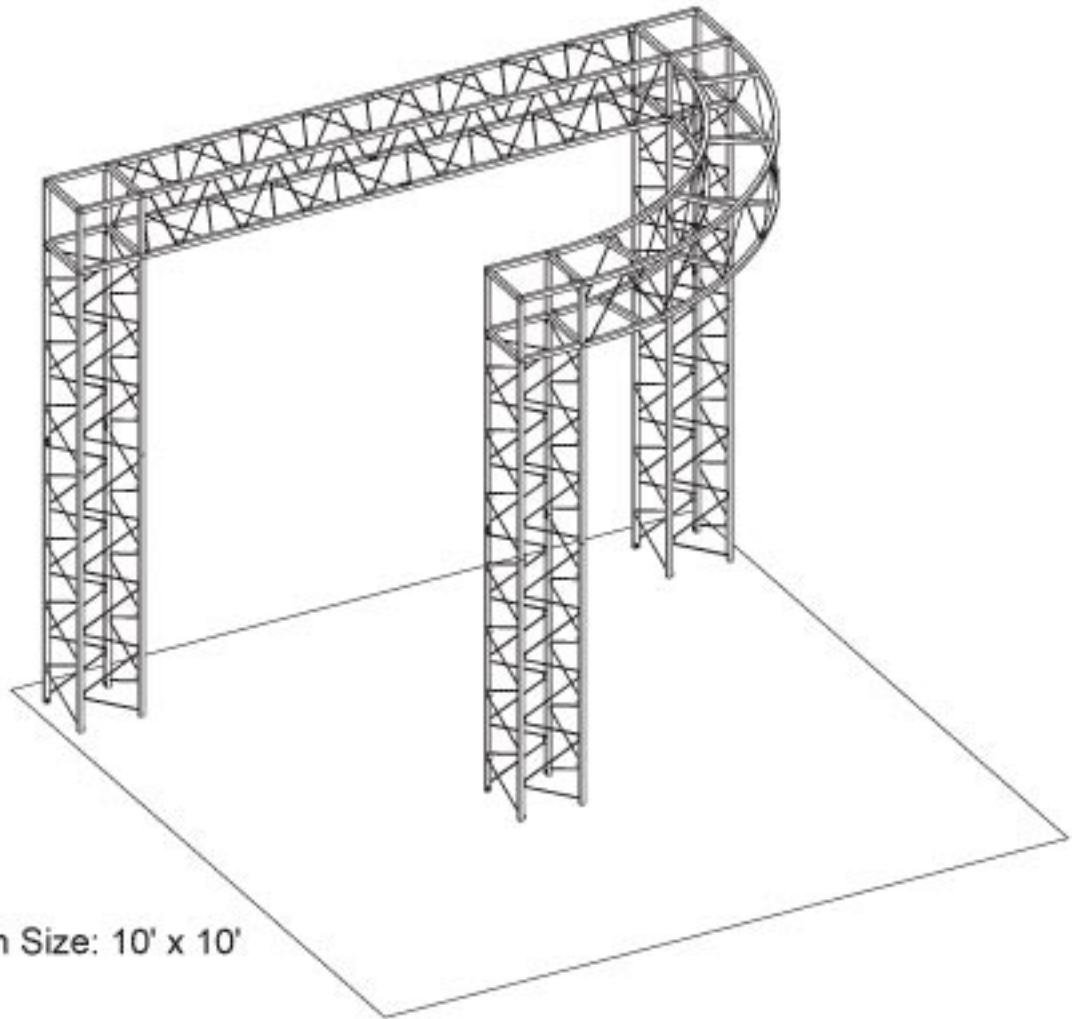

Booth Size: 10' x 10'

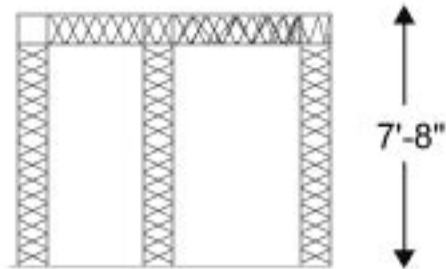
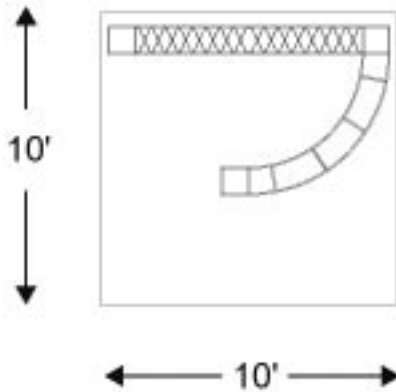

Elevation View

Design - 0038

Approx. Total Wt. = 160#

Shipping Class: 125



Quantity	Part Description	Part Number
3	STOWAWAY BOX STRAIGHT 34.5	SQA3
5	STOWAWAY BOX STRAIGHT 46	SQA4
2	STOWAWAY BOX CRV 57.5R 45° HORIZ	SQM2
2	STOWAWAY CUBE INT RIGID 90° 2 WAY K/D	SQX21
1	STOWAWAY CUBE INT RIGID 90° 3 WAY K/D	SQX23
2	STOWAWAY ARM LIGHT	SAU31
2	STOWAWAY MOLDED SHIPPING CASE	SAU26



800-457-2369 • 801-409-9036 fax

Miriam inc

Marketing Agency

Design-0039

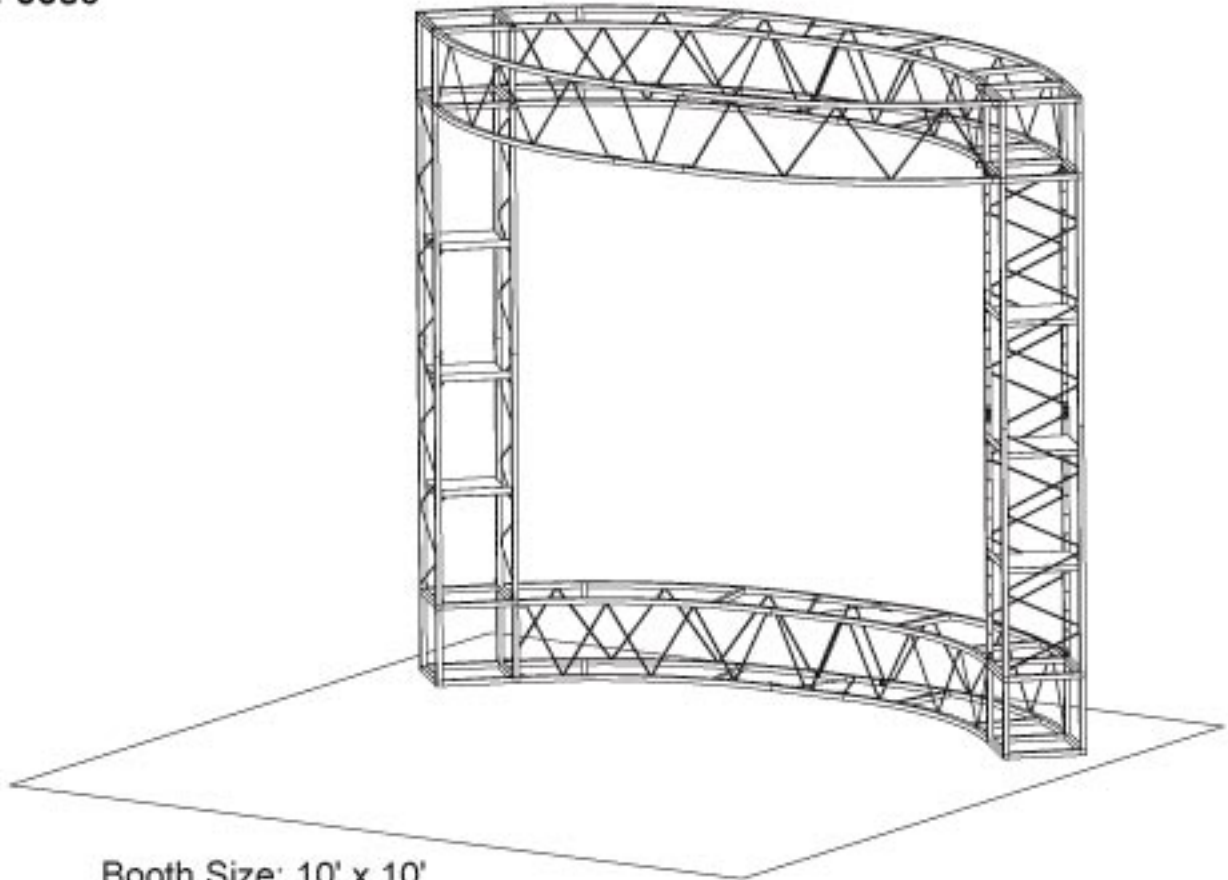

Booth Size: 10' x 10'

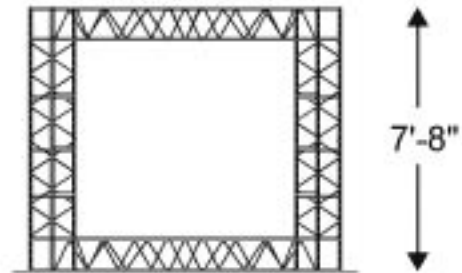
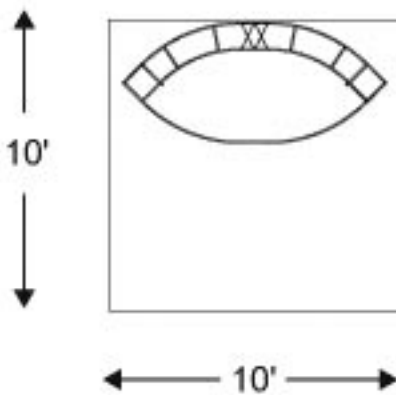

Design - 0039

Approx. Total Wt. = 180#

Shipping Class: 100

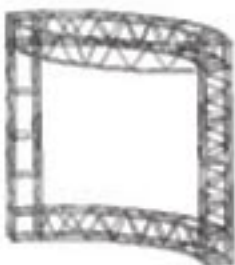

Quantity	Part Description	Part Number
2	STOWAWAY BOX STRAIGHT 11.5	SQA1
4	STOWAWAY BOX STRAIGHT 34.5 FOR SHELVES	SQA3A
4	STOWAWAY BOX CRV 57.5R 45° HORIZ	SQM2
2	STOWAWAY CUBE INT RIGID 90° 2 WAY	SQX1
2	STOWAWAY CUBE INT RIGID 90° 3 WAY	SQX3
2	STOWAWAY FLAT CURVE 45° H	SFM2A
6	STOWAWAY SHELF - RECESSED	SAU1
2	STOWAWAY ARM LIGHT	SAU31
2	STOWAWAY MOLDED SHIPPING CASE	SAU26



800-457-2369 • 801-409-9036 fax

Miriam inc

Marketing Agency

Design-0040

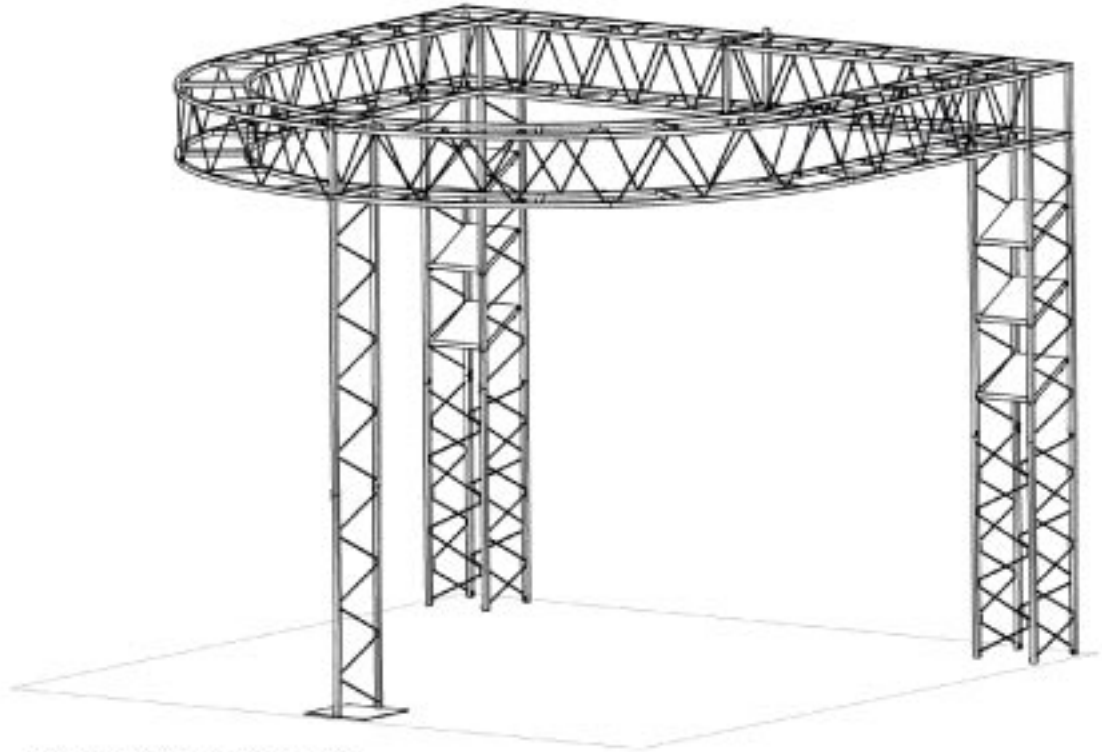

Booth Size: 10' x 10'

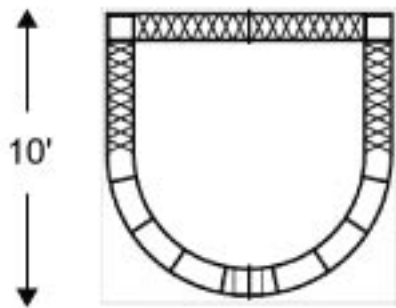

10'

10'

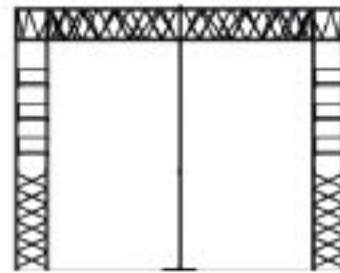

7'-8"

Design - 0040

Approx. Total Wt. = 220#

Shipping Class: 125



Quantity	Part Description	Part Number
2	STOWAWAY BOX STRAIGHT 34.5	SQA3
4	STOWAWAY BOX STRAIGHT 46	SQA4
2	STOWAWAY BOX STRAIGHT 46 IN FOR SHELVES	SQA4A
4	STOWAWAY BOX CRV 57.5R 45° HORIZ	SQM2
2	STOWAWAY CUBE INT RIGID 90° 3 WAY	SQX3
1	STOWAWAY FLAT STRAIGHT 34.5	SFA3
1	STOWAWAY FLAT STRAIGHT 46	SFA4
1	STOWAWAY FLAT INT BOX 2 FLAT 0	SFX16
1	STOWAWAY FLAT INT BOX 2 FLAT 1	SFX17
1	STOWAWAY BASE PLATE SMALL	SQU5
6	STOWAWAY SHELF - RECESSED	SAU1
2	STOWAWAY ARM LIGHT	SAU31
3	STOWAWAY MOLDED SHIPPING CASE	SAU26



Design-0041

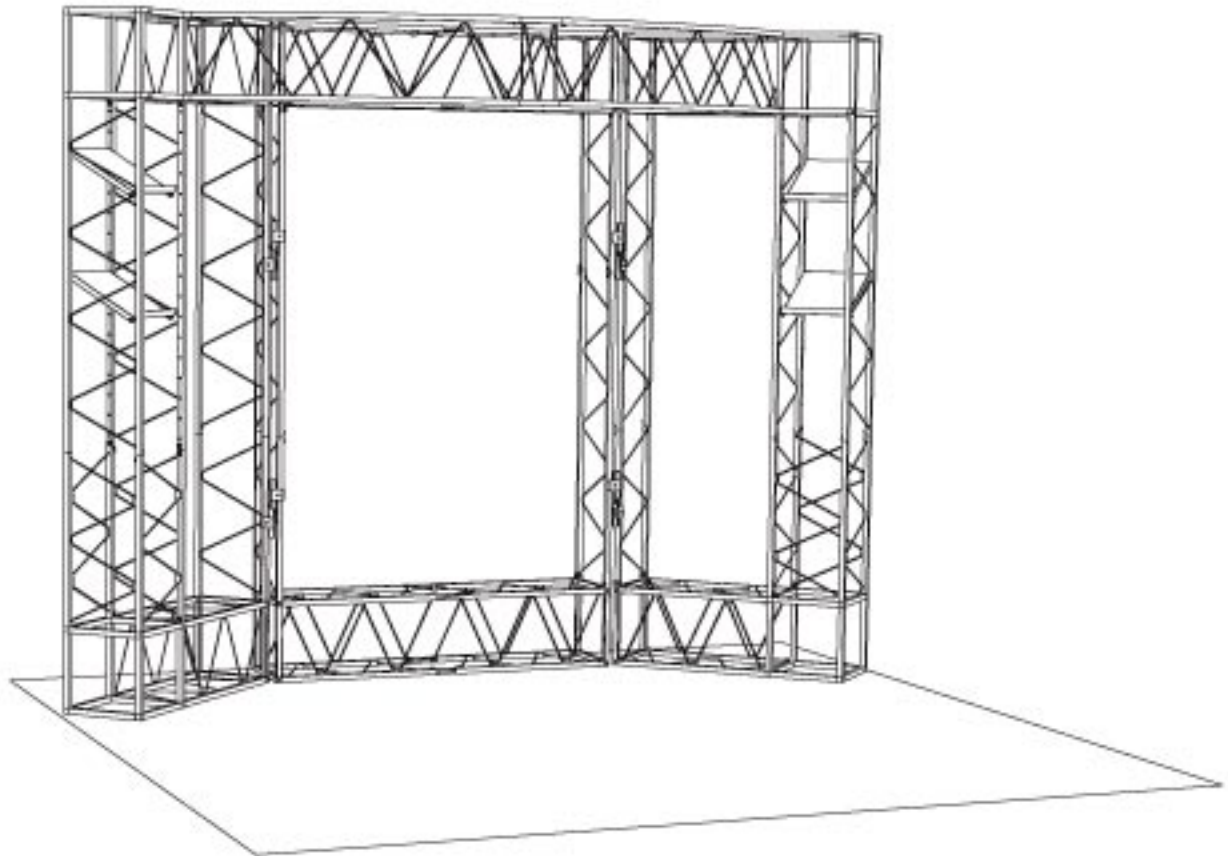

Booth Size: 10' x 10'

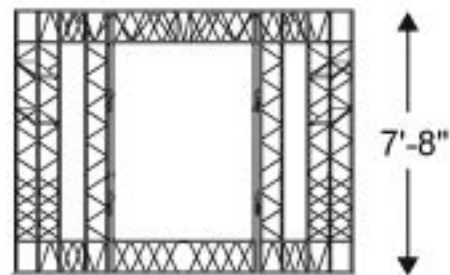
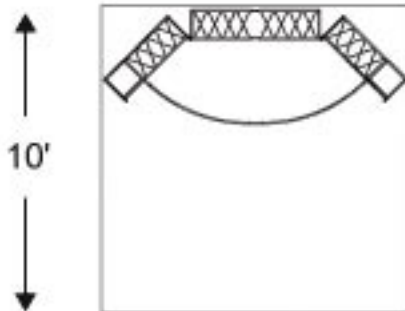

Design - 0041

Approx. Total Wt. = 295#

Shipping Class: 100

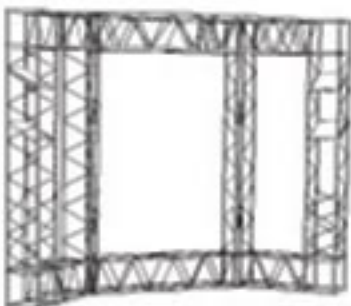

Quantity	Part Description	Part Number
1	STOWAWAY FLAT STRAIGHT 5.75	SFA0
4	STOWAWAY FLAT STRAIGHT 23	SFA2
4	STOWAWAY FLAT STRAIGHT 46	SFA4
2	STOWAWAY FLAT CURVE 45° H	SFM2A
8	STOWAWAY FLAT INT BOX 1 FLAT 1	SFX11
10	STOWAWAY BOX STRAIGHT 23	SQA2
2	STOWAWAY BOX STRAIGHT 46 IN FOR SHELVES	SQA4A
2	STOWAWAY CUBE INT RIGID 90° 2 WAY	SQX1
2	STOWAWAY CUBE INT RIGID 90° 3 WAY	SQX3
4	STOWAWAY SHELF - RECESSED	SAU1
8	STOWAWAY EXTENDER 1-4 BLK	SAU3
4	STOWAWAY HALF CONNECTOR WALL MOUNT	SAU5
8	STOWAWAY ACCESSORY BRACKET	SAU7
4	STOWAWAY HALF CONNECTOR W/THRU HOLE	SAU15
3	STOWAWAY ARM LIGHT	SAU31
3	STOWAWAY MOLDED SHIPPING CASE	SAU26



800-457-2369 • 801-409-9036 fax

Miriam inc

Marketing Agency

Design-0042

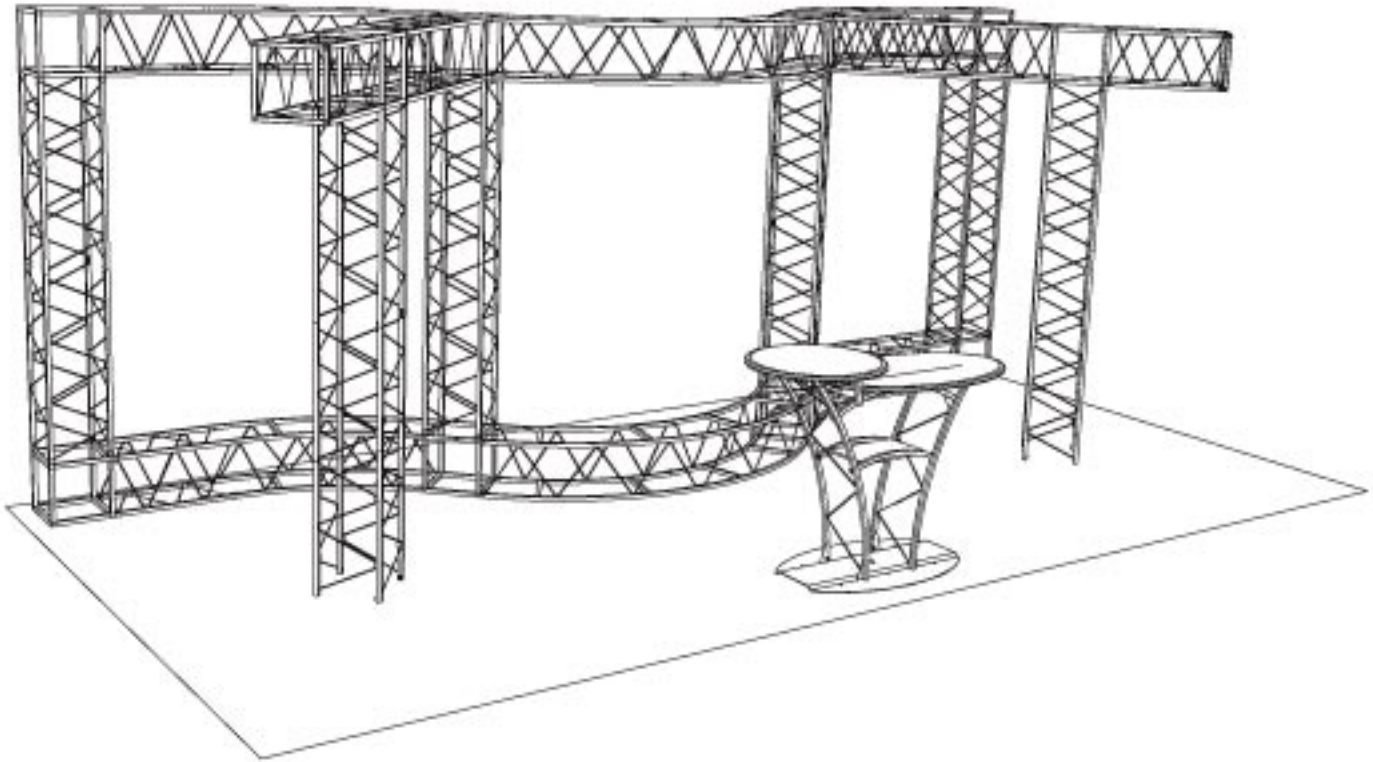

Booth Size: 10' x 20'

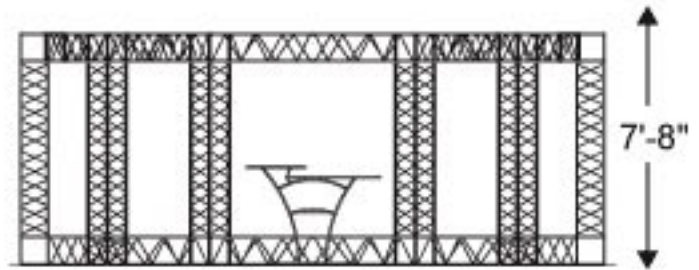
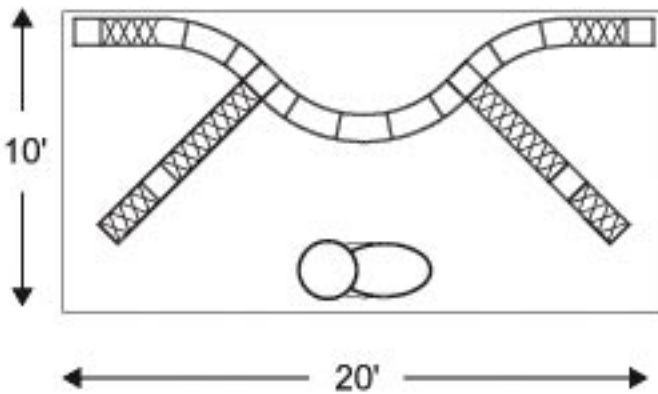

Design - 0042

Approx. Total Wt. = 550#

Shipping Class: 125

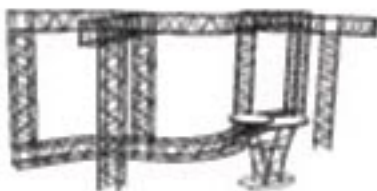

Quantity	Part Description	Part Number
6	STOWAWAY BOX STRAIGHT 23	SQA2
10	STOWAWAY BOX STRAIGHT 34.5	SQA3
4	STOWAWAY BOX STRAIGHT 46	SQA4
8	STOWAWAY BOX CRV 57.5R 45° HORIZ	SQM2
4	STOWAWAY CUBE INT RIGID 90° 2 WAY	SQX1
4	STOWAWAY CUBE INT RIGID 3WAY	SQX4
2	STOWAWAY CUBE INT RIGID 90° 4 WAY	SQX5
2	STOWAWAY FLAT INT BOX 1 FLAT 0	SFX10
4	STOWAWAY ARM LIGHT	SAU31
2	STOWAWAY MOLDED SHIPPING TUB	SAU35
1	RY MULTI-TIERED COUNTER/CASE	22001



800-457-2369 • 801-409-9036 fax

Miriam inc

Marketing Agency

Design-0043

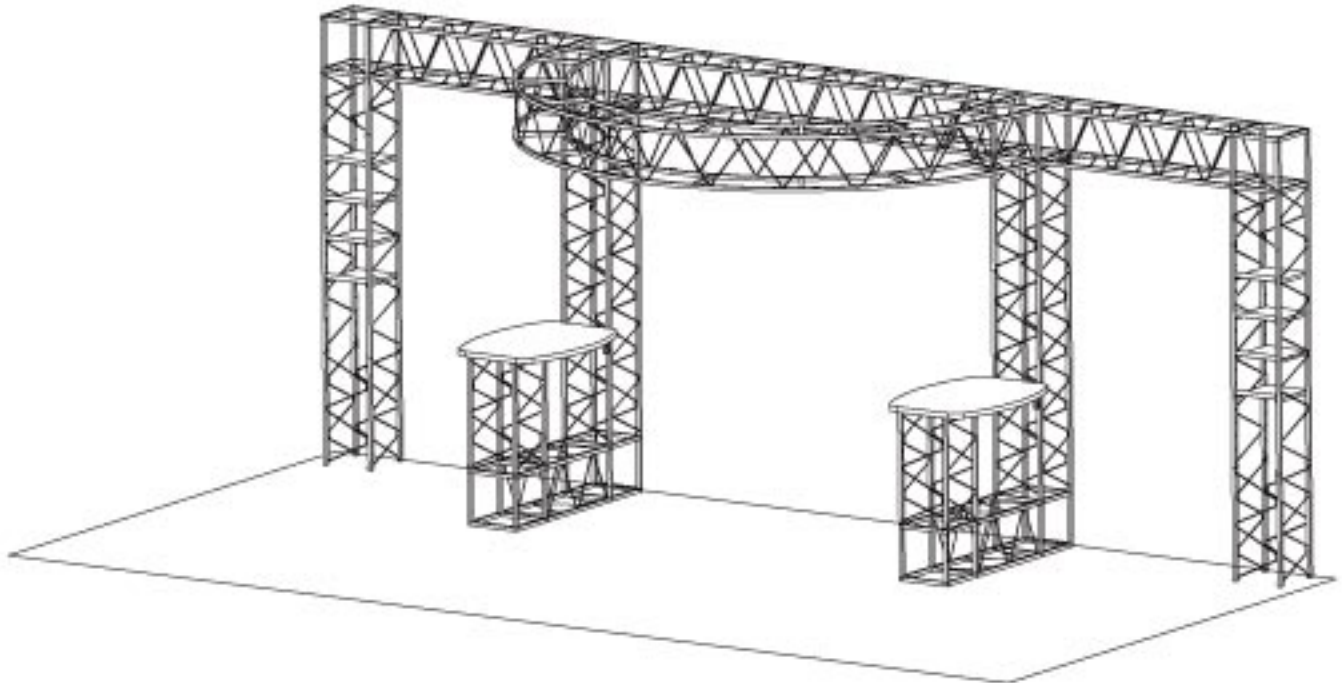

Booth Size: 10' x 20'

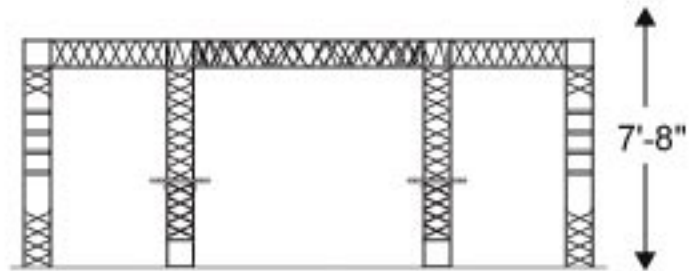
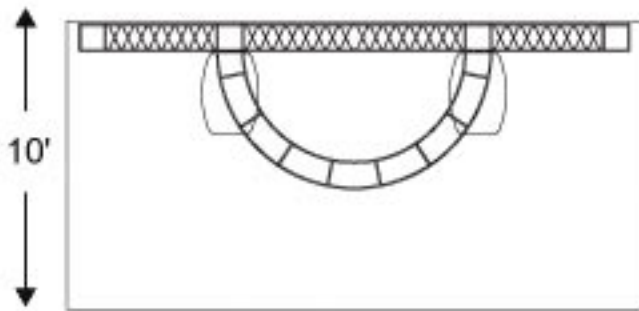

20'

Design - 0043

Approx. Total Wt. = 450#

Shipping Class: 150



Quantity

- 2
- 8
- 6
- 2
- 4
- 6
- 2
- 8
- 2
- 6
- 2

Part Description

- STOWAWAY BOX STRAIGHT 11.5
- STOWAWAY BOX STRAIGHT 23
- STOWAWAY BOX STRAIGHT 46
- STOWAWAY BOX STRAIGHT 46 IN FOR SHELVES
- STOWAWAY BOX CRV 57.5R 45° HORIZ
- STOWAWAY CUBE INT RIGID 90° 2 WAY
- STOWAWAY CUBE INT RIGID 90° 4 WAY
- STOWAWAY SHELF - RECESSED
- STOWAWAY COUNTER TOP KIT
- STOWAWAY ARM LIGHT KIT
- STOWAWAY MOLDED SHIPPING TUB

Part Number

- SQA1
- SQA2
- SQA4
- SQA4A
- SQM2
- SQX1
- SQX5
- SAU1
- SAU13
- SAU31
- SAU35



800-457-2369 • 801-409-9036 fax

Miriam inc

Marketing Agency

Design-0044

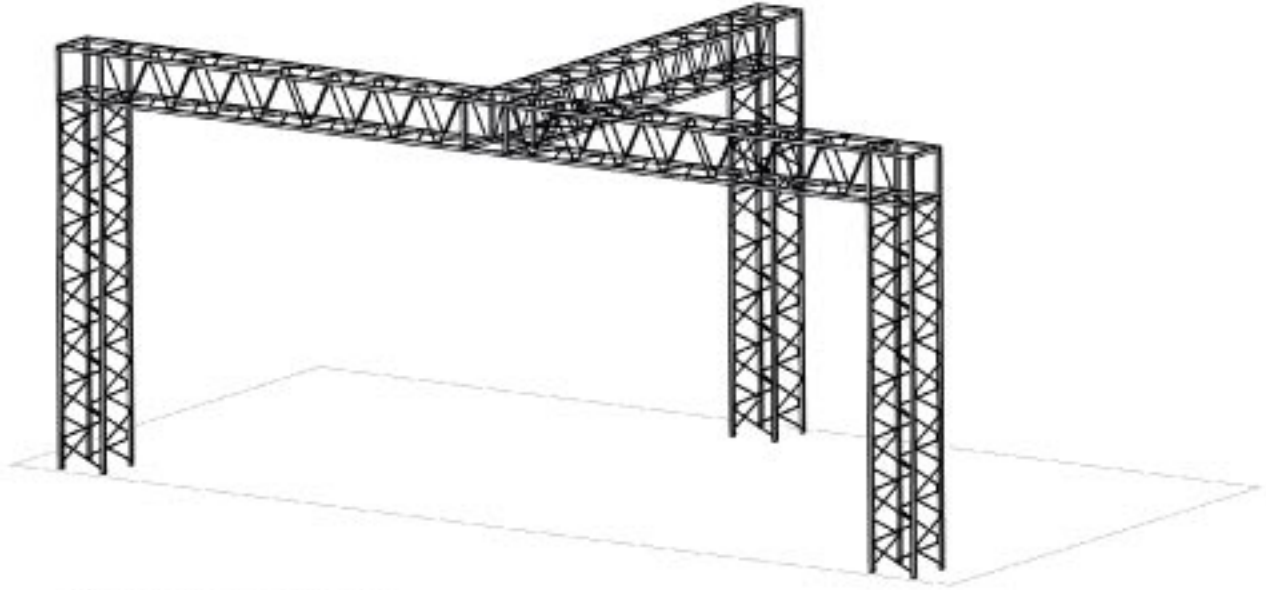

Booth Size: 10' x 20'

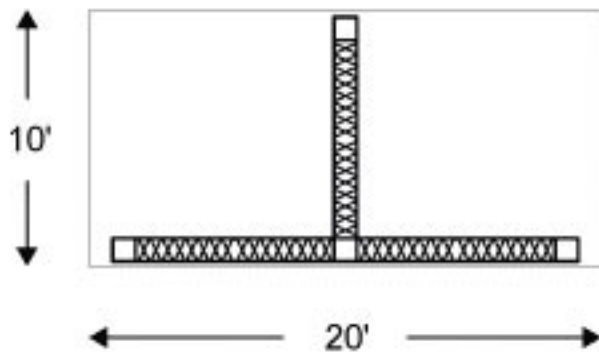

Plan View

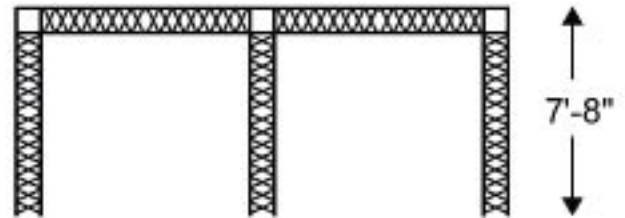

Elevation View

Design - 0044

Approx. Total Wt. = 200#

Shipping Class: 125



Quantity

- 3
- 9
- 3
- 1
- 4
- 3

Part Description

- STOWAWAY BOX STRAIGHT 34.5
- STOWAWAY BOX STRAIGHT 46
- STOWAWAY CUBE INT RIGID 90° 2 WAY
- STOWAWAY CUBE INT RIGID 3WAY
- STOWAWAY ARM LIGHT
- STOWAWAY MOLDED SHIPPING CASE

Part Number

- SQA3
- SQA4
- SQX1
- SQX4
- SAU31
- SAU26



800-457-2369 • 801-409-9036 fax

Miriam inc

Marketing Agency

Design-0045

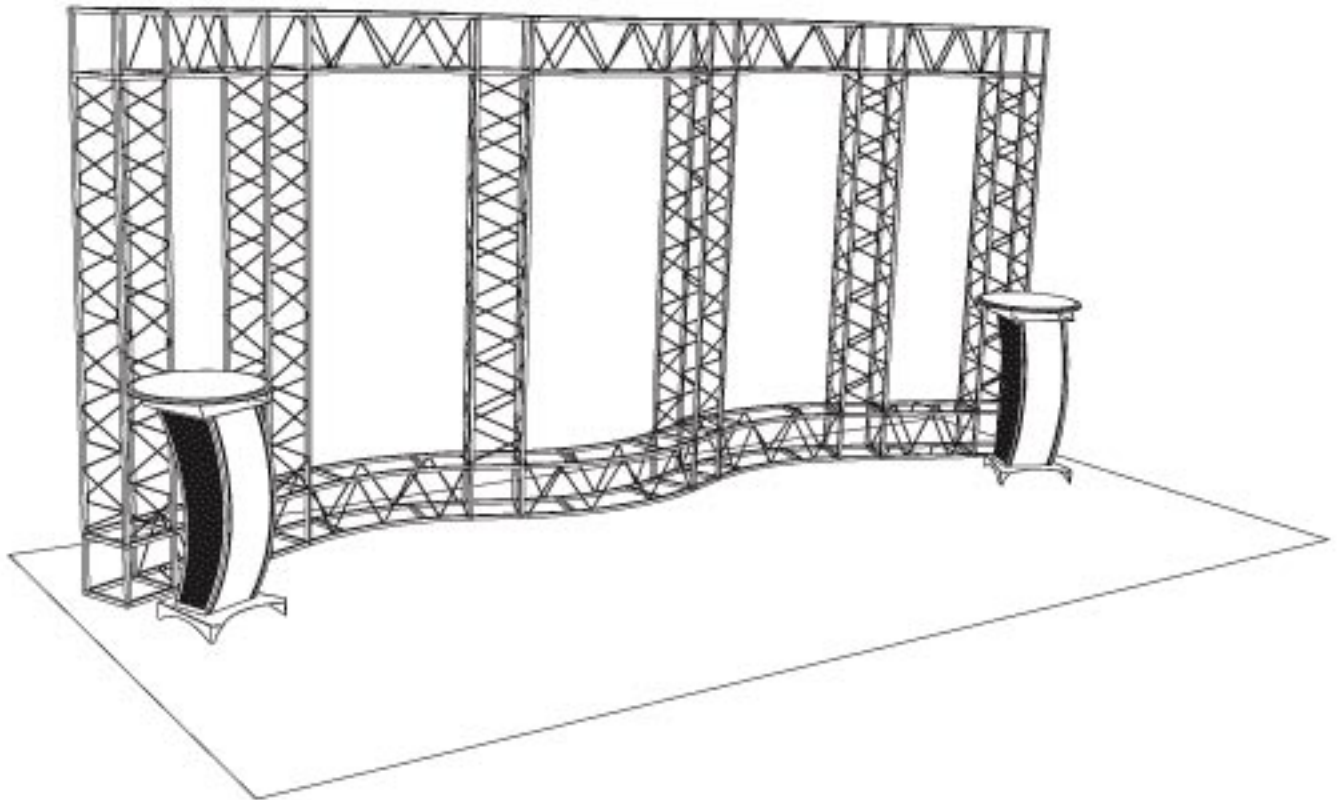

Booth Size: 10' x 20'

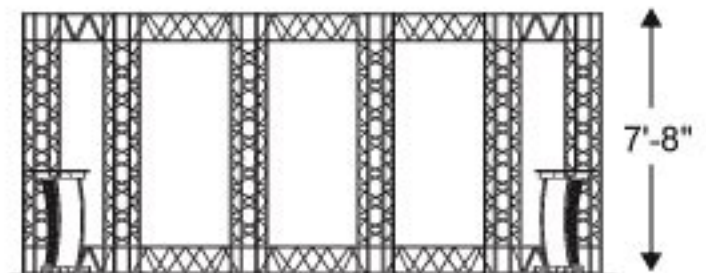
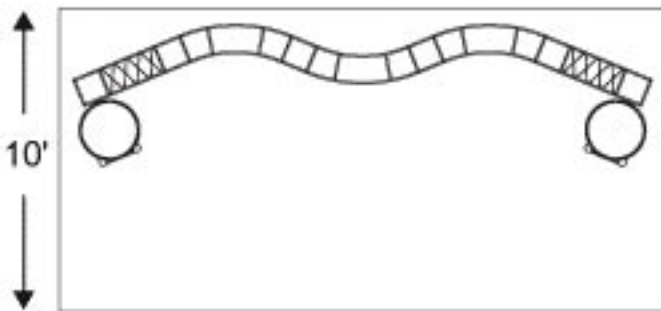

20'

Design - 0045

Approx. Total Wt. = 515

Shipping Class: 125

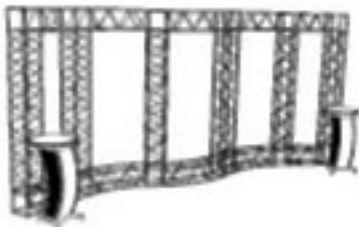

Quantity

- 4
- 6
- 6
- 6
- 4
- 8
- 2
- 6
- 2

Part Description

- STOWAWAY BOX STRAIGHT 23
- STOWAWAY BOX STRAIGHT 34.5
- STOWAWAY BOX STRAIGHT 46
- STOWAWAY BOX CRV 57.5R 45° HORIZ
- STOWAWAY CUBE INT RIGID 90° 2 WAY
- STOWAWAY CUBE INT RIGID 3WAY
- VS COUNTER /SIDES, BASE, FRONT, SHELF
- STOWAWAY ARM LIGHT
- STOWAWAY MOLDED SHIPPING TUB

Part Number

- SQA2
- SQA3
- SQA4
- SQM2
- SQX1
- SQX4
- 21200
- SAU31
- SAU35



800-457-2369 • 801-409-9036 fax

Miriam inc

Marketing Agency

Design-0046

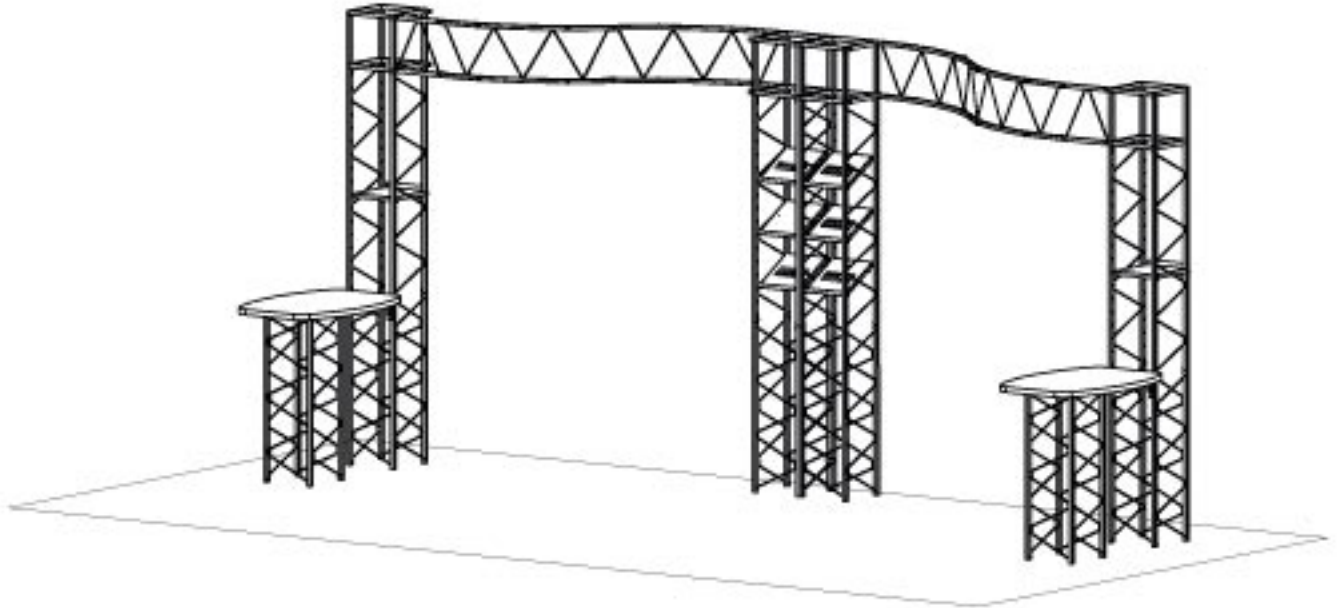

Booth Size: 10' x 20'

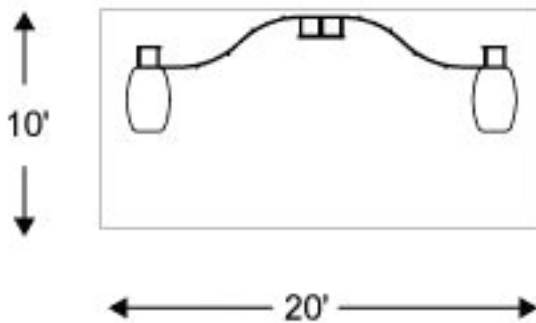

Plan View

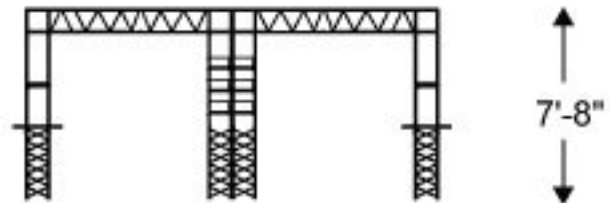

Elevation View

Design - 0046

Approx. Total Wt. = 290#

Shipping Class: 125



Quantity
2
4
6
4
4
4
6
2
4
4
4

Part Description
STOWAWAY FLAT STRAIGHT 11.5
STOWAWAY FLAT CURVE 45° H
STOWAWAY BOX STRAIGHT 34.5
STOWAWAY BOX STRAIGHT 46 IN FOR SHELVES
STOWAWAY CUBE INT RIGID 90° 2 WAY K/D
STOWAWAY SHELF - RECESSED
STOWAWAY COUNTER TOP KIT
STOWAWAY ARM LIGHT
STOWAWAY MOLDED SHIPPING CASE

Part Number
SFA1
SFM2B
SQA3
SQA4A
SQX21
SAU1
SAU13
SAU31
SAU26



800-457-2369 • 801-409-9036 fax

Miriam inc

Marketing Agency

Design-0047

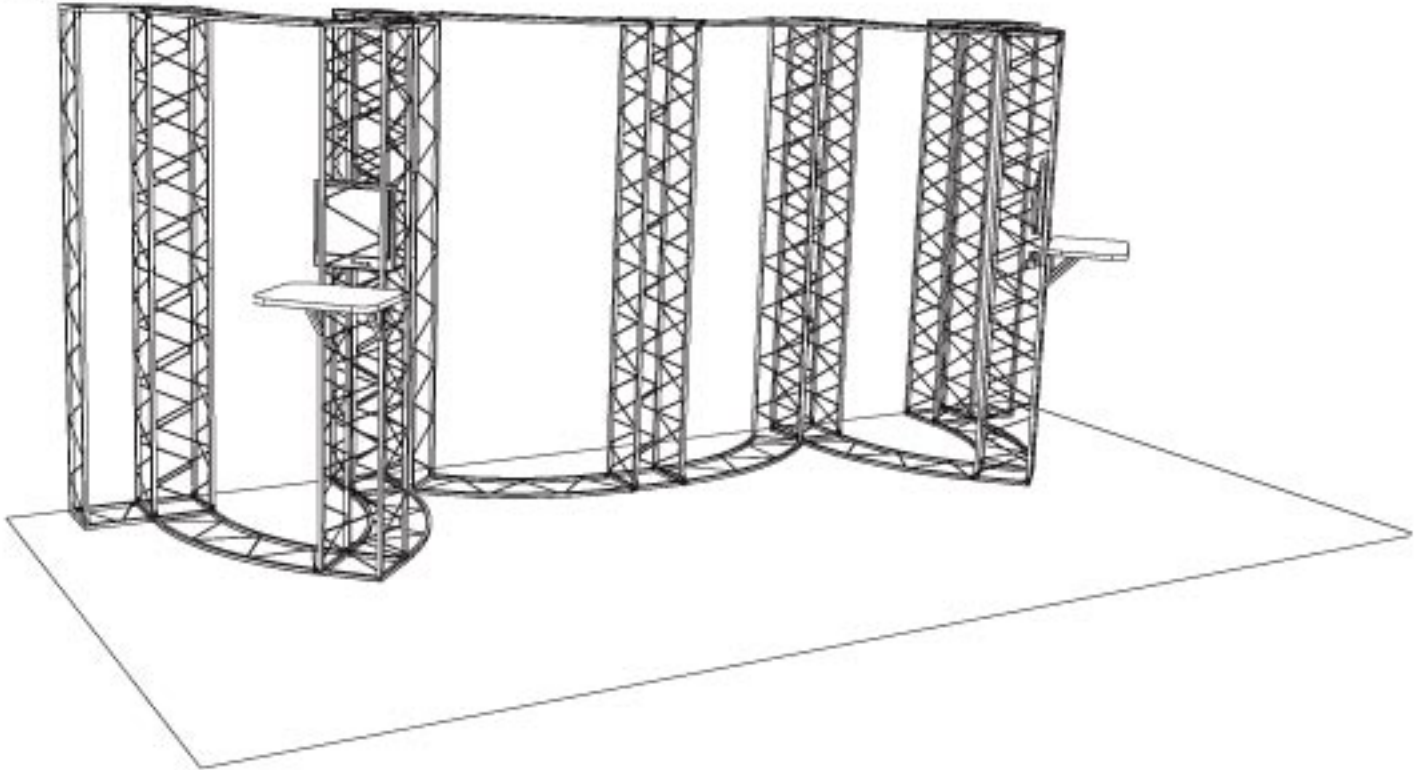

Booth Size: 10' x 20'

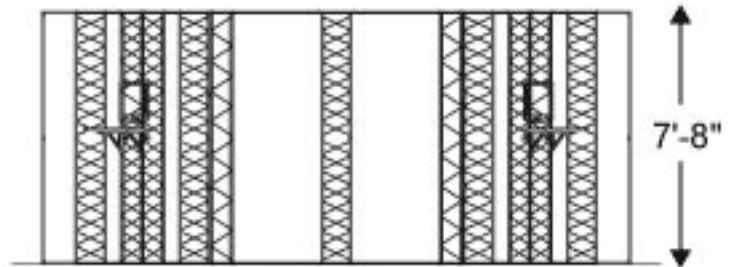
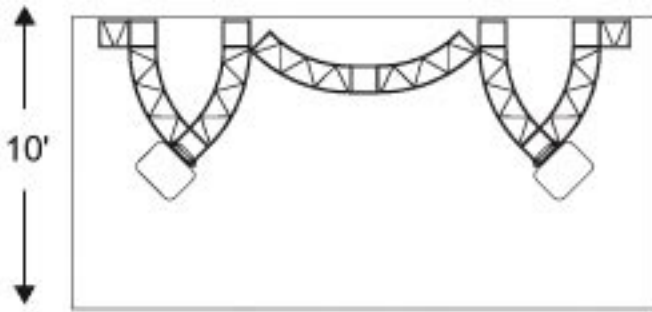

Design - 0047

Approx. Total Wt. = 410#

Shipping Class: 100

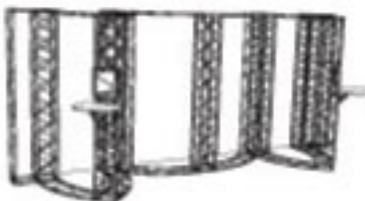

Quantity
14
4
8
12
8
4
8
2
6
2
5
2

Part Description
STOWAWAY BOX STRAIGHT 46
STOWAWAY FLAT STRAIGHT 11.5
STOWAWAY FLAT STRAIGHT 46
STOWAWAY FLAT CURVE 45° V
STOWAWAY FLAT CUBE 90 2 PLN 2 WAY
STOWAWAY FLAT INT BOX 1 FLAT 1
STOWAWAY FLAT INT BOX 1 FLAT 2
STOWAWAY FLAT INT BOX 1 FLAT 2
STOWAWAY ARM LIGHT
STOWAWAY SURFACE SCREEN MOUNT
STOWAWAY MOLDED SHIPPING CASE
STOWAWAY SHELF 16X21 W/BRKTS

Part Number
SQA4
SFA1
SFA4
SFM1
SFX5
SFX11
SFX12
SFX13
SAU31
SAU14
SAU26
43140

Design-0048



RY series

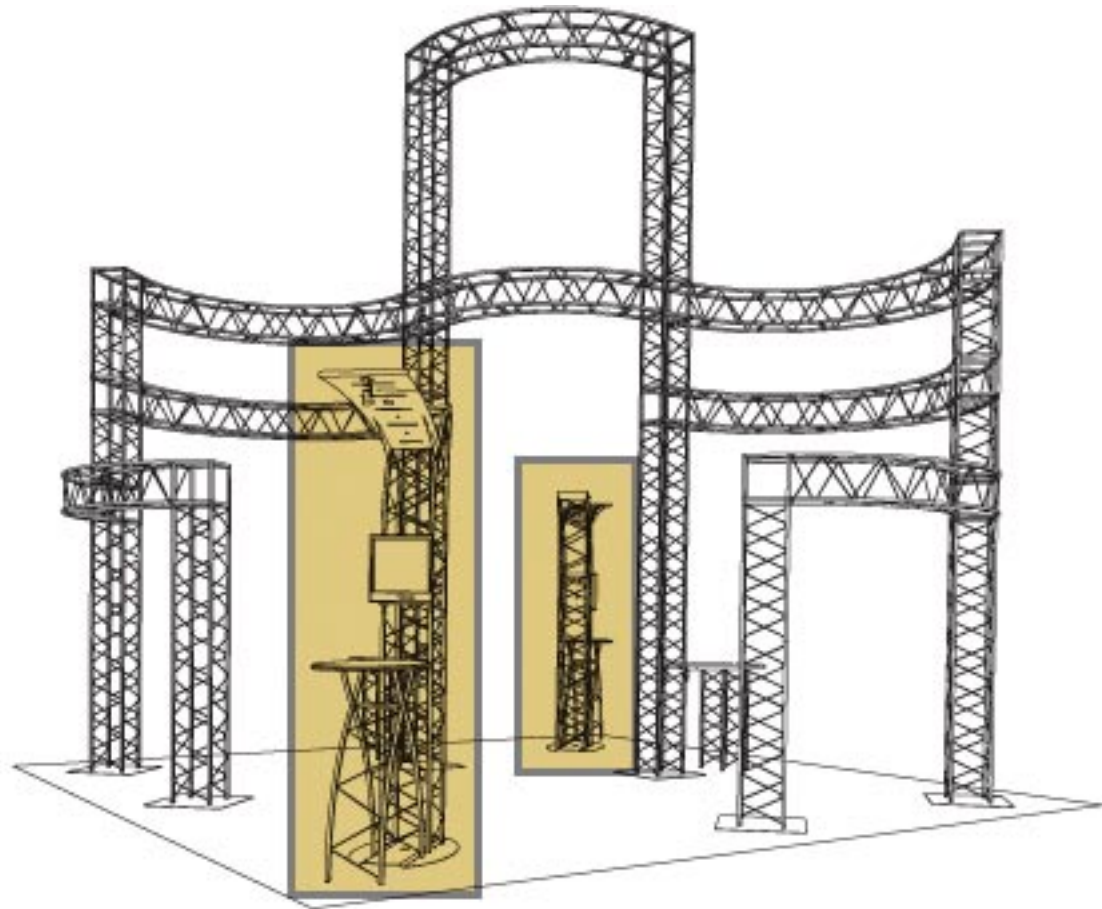

featuring **INTERLOCK**elements®

Booth Size: 20' x 20'

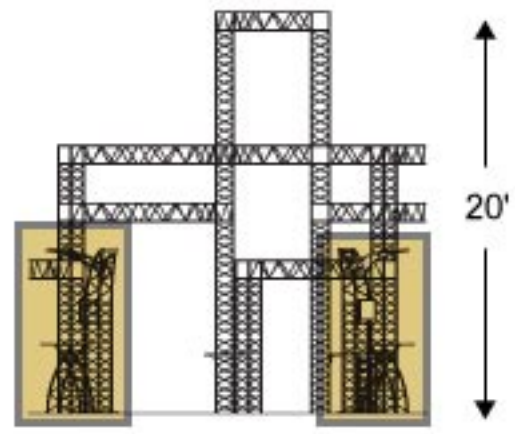
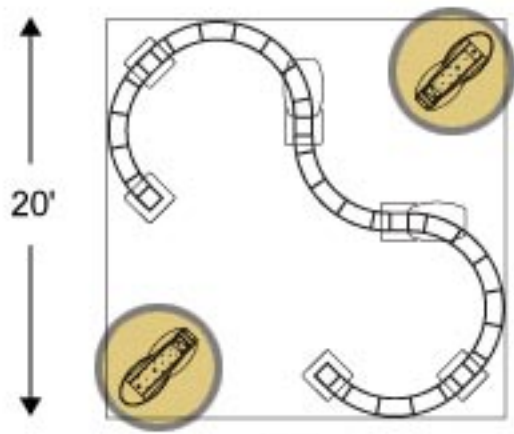

Elevation View

Design - 0048

Approx. Total Wt. = 950#

Shipping Class: 125

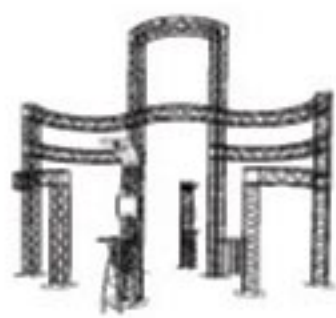

Quantity	Part Description	Part Number
8	STOWAWAY BOX STRAIGHT 23	SQA2
10	STOWAWAY BOX STRAIGHT 34.5	SQA3
8	STOWAWAY BOX STRAIGHT 46	SQA4
20	STOWAWAY BOX CRV 57.5R 45° HORIZ	SQM2
6	STOWAWAY CUBE INT RIGID 90° 2 WAY	SQX1
6	STOWAWAY CUBE INT RIGID 3WAY	SQX4
2	STOWAWAY CUBE INT RIGID 4 WAY	SQX6
6	STOWAWAY BASE PLATE LARGE	SQU6
2	STOWAWAY COUNTER TOP KIT	SAU13
14	STOWAWAY ARM LIGHT	SAU31
3	STOWAWAY MOLDED SHIPPING TUB	SAU35
2	RY ELECTRONIC PRESENTATION TOWER	22002



800-457-2369 • 801-409-9036 fax

Miriam inc

Marketing Agency

Design-0049

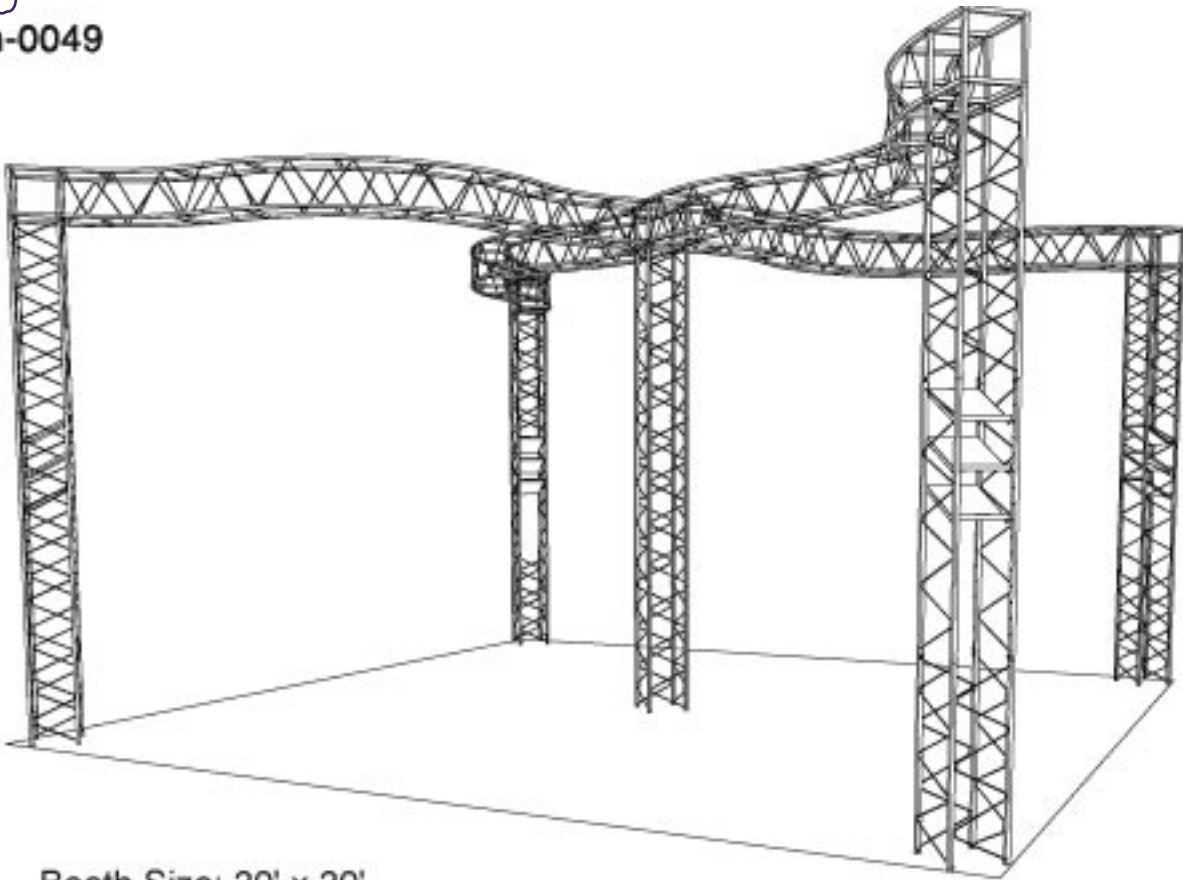

Booth Size: 20' x 20'

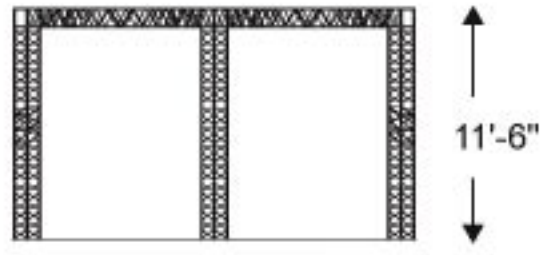
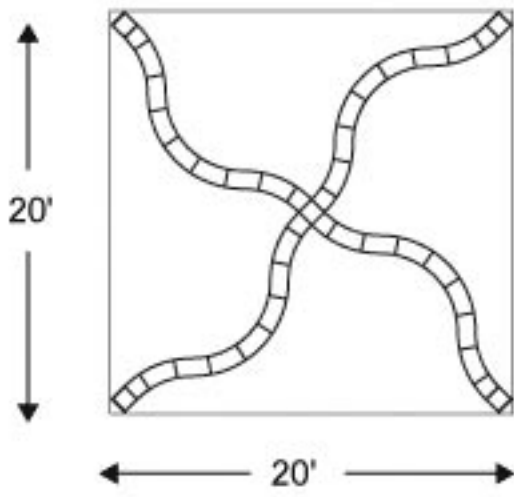

Elevation View

Design - 0049

Approx. Total Wt. = 580#

Shipping Class: 150



Quantity
5
5
5
16
4
1
12
8
3

Part Description	Part Number
STOWAWAY BOX STRAIGHT 34.5	SQA3
STOWAWAY BOX STRAIGHT 46	SQA4
STOWAWAY BOX STRAIGHT 46 IN FOR SHELVES	SQA4A
STOWAWAY BOX CRV 57.5R 45° HORIZ	SQM2
STOWAWAY CUBE INT RIGID 90° 2 WAY	SQX1
STOWAWAY CUBE INT RIG 5WAY	SQX7
STOWAWAY SHELF - RECESSED	SAU1
STOWAWAY ARM LIGHT	SAU31
STOWAWAY MOLDED SHIPPING TUB	SAU35



800-457-2369 • 801-409-9036 fax

Miriam inc

Marketing Agency

Design-0050

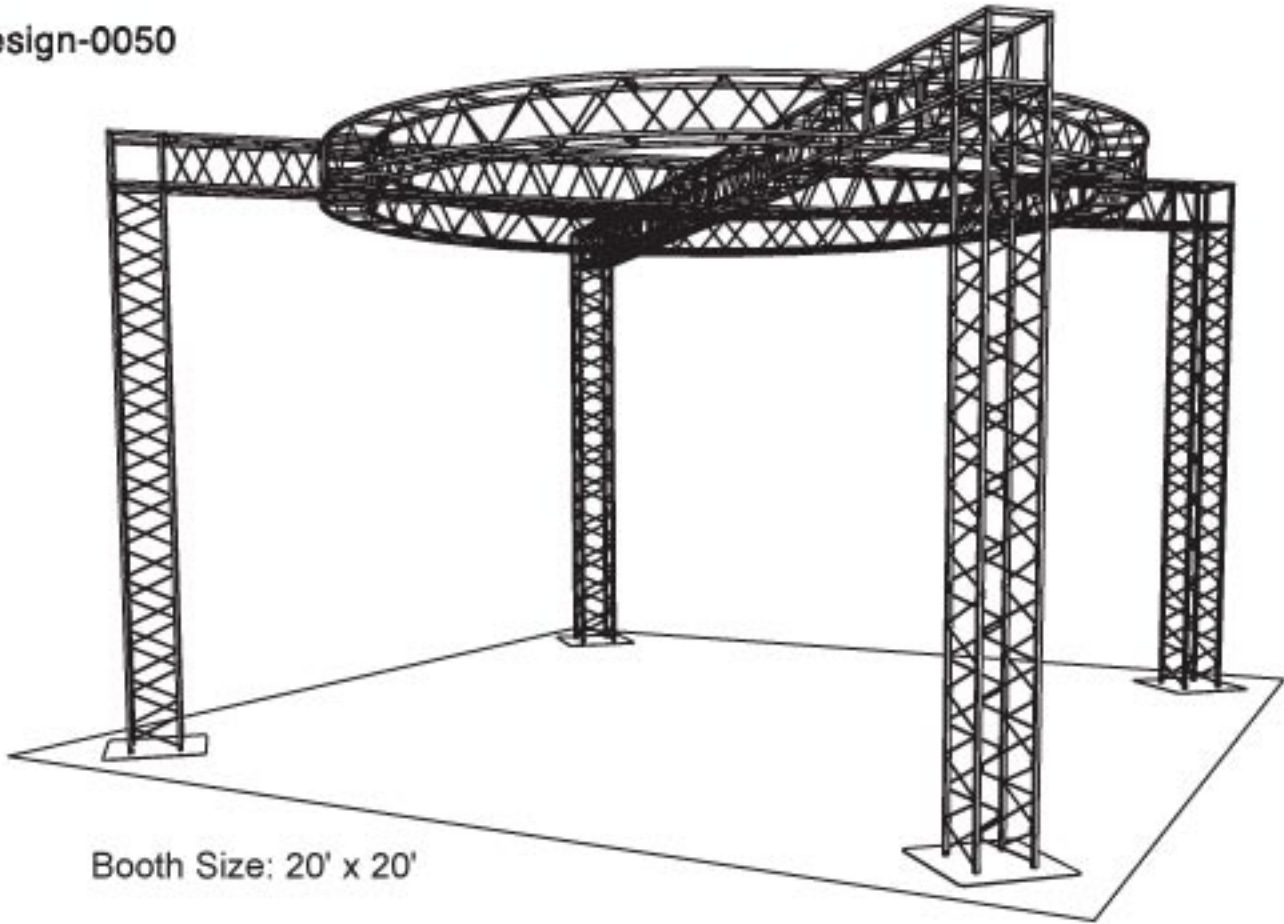

Booth Size: 20' x 20'

20'

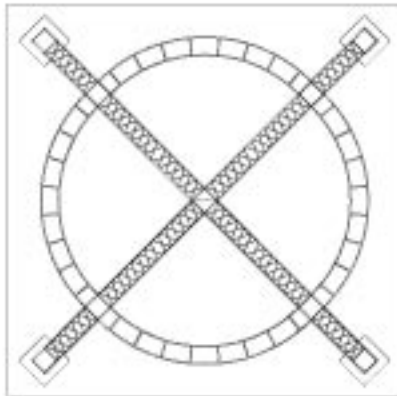

11'-6"

Elevation View

Design - 0050

Approx. Total Wt. = 635#

Shipping Class: 125



Quantity

12
12
16
4
5
4
8
1
2

Part Description

STOWAWAY BOX STRAIGHT 34.5
STOWAWAY BOX STRAIGHT 46
STOWAWAY BOX CRV 92R 22.5" H
STOWAWAY CUBE INT RIGID 90° 2 WAY
STOWAWAY CUBE INT RIG 4WAY
STOWAWAY BASE PLATE LARGE
STOWAWAY ARM LIGHT
STOWAWAY MOLDED SHIPPING CASE
STOWAWAY MOLDED SHIPPING TUB

Part Number

SQA3
SQA4
SQO2
SQX1
SQX6
SQU6
SAU31
SAU26
SAU35



Design-0051

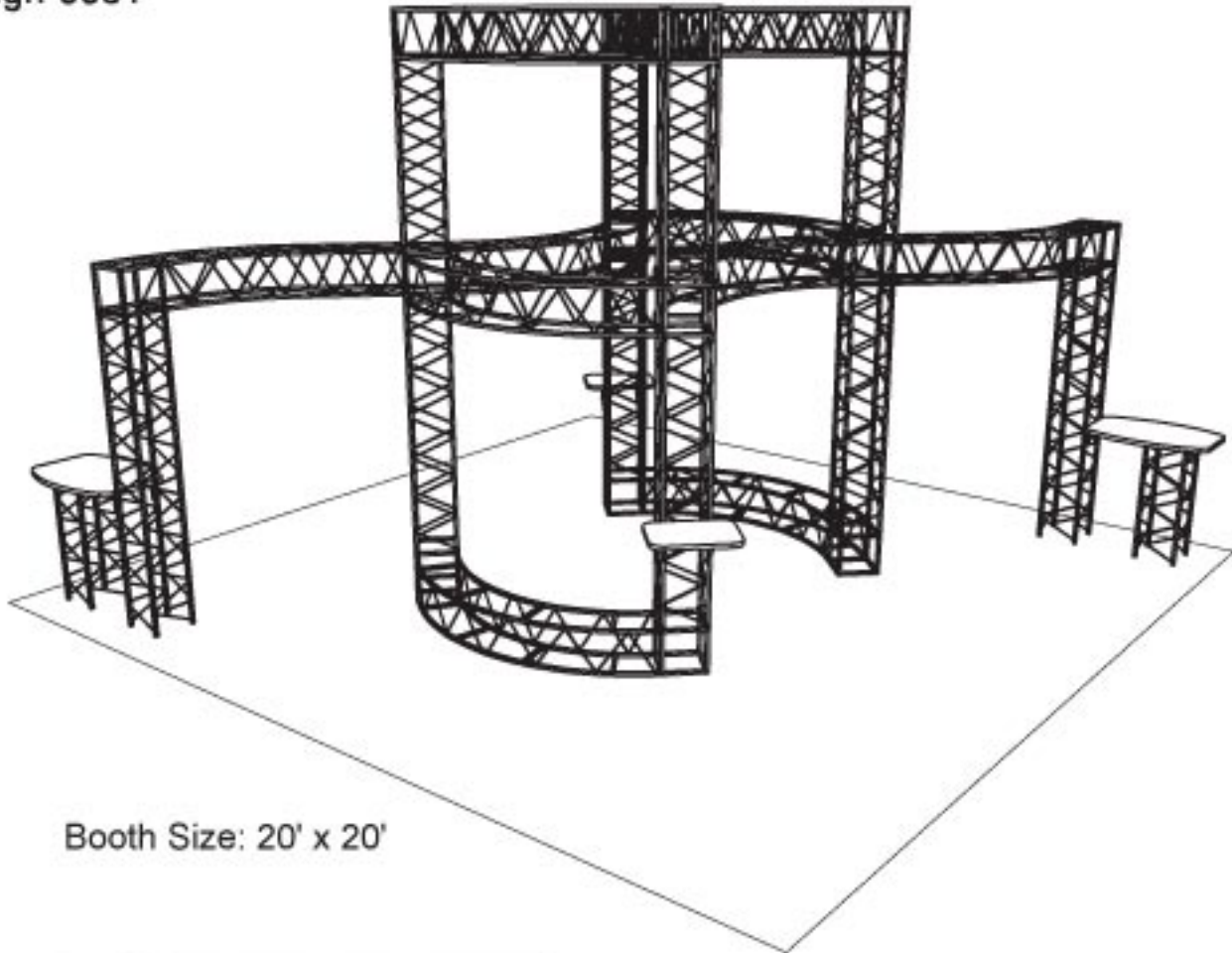

Booth Size: 20' x 20'

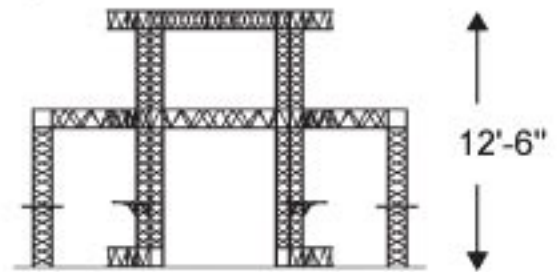
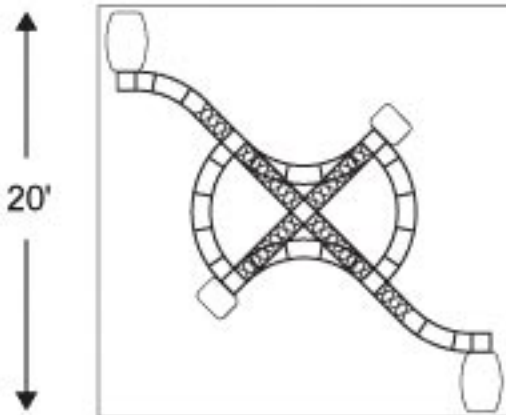

Elevation View

Design - 0051

Approx. Total Wt. = 820#

Shipping Class: 125

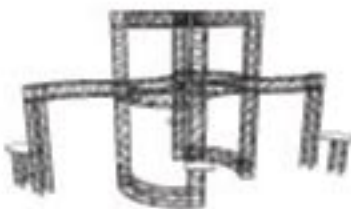

Quantity
2
12
10
18
6
4
2
1
2
2
2
8
4

Part Description

- STOWAWAY BOX STRAIGHT 23
- STOWAWAY BOX STRAIGHT 34.5
- STOWAWAY BOX STRAIGHT 46
- STOWAWAY BOX CRV 57.5R 45° HORIZ
- STOWAWAY CUBE INT RIGID 90° 2 WAY
- STOWAWAY CUBE INT RIGID 90° 3 WAY
- STOWAWAY CUBE INT RIGID 90° 4 WAY
- STOWAWAY CUBE INT RIG 4WAY
- STOWAWAY CUBE INT RIG 5WAY
- STOWAWAY SHELF 16X21 WBRKTS
- STOWAWAY COUNTER TOP KIT
- STOWAWAY ARM LIGHT
- STOWAWAY MOLDED SHIPPING TUB

Part Number
SQA2
SQA3
SQA4
SQM2
SQX1
SQX3
SQX5
SQX6
SQX7
43140
SAU13
SAU31
SAU35



800-457-2369 • 801-409-9036 fax

Miriam inc

Marketing Agency

Design-0052

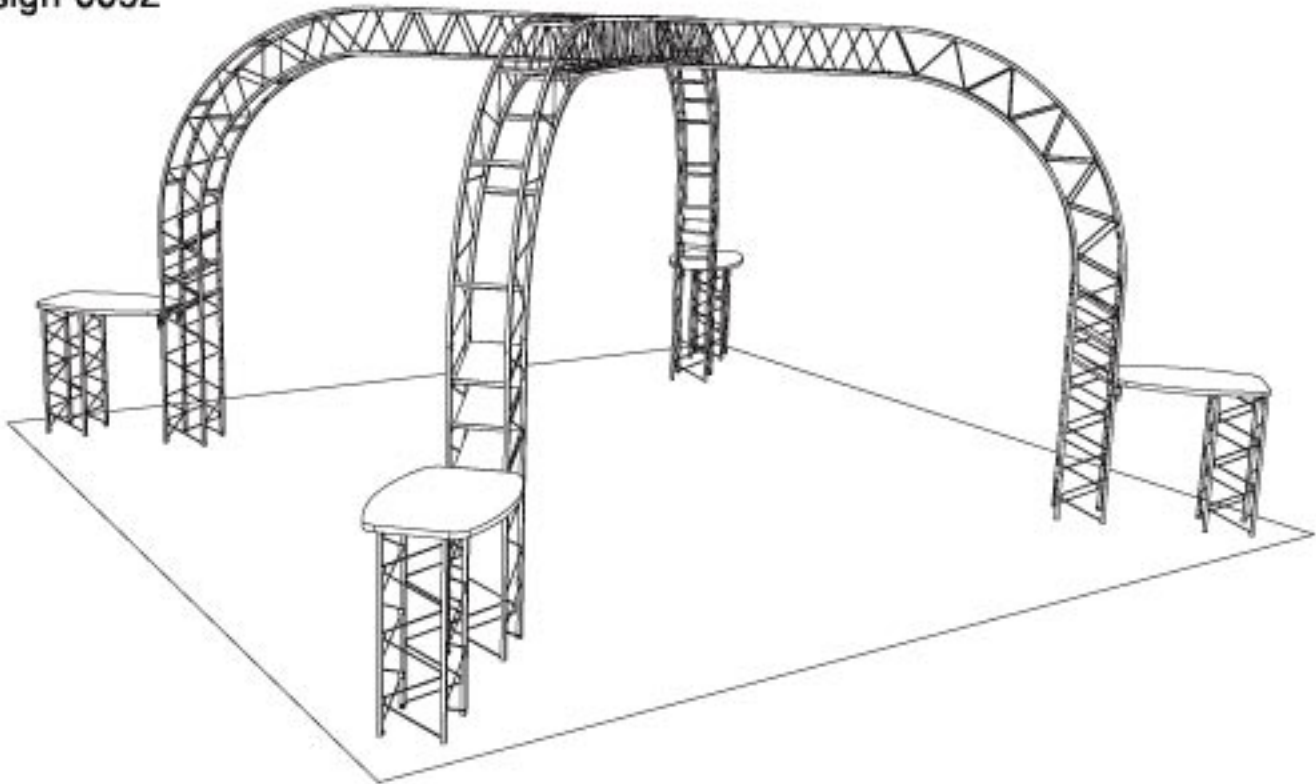

Booth Size: 20' x 20'

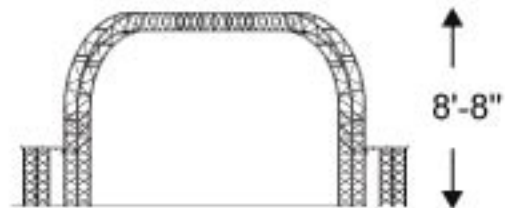
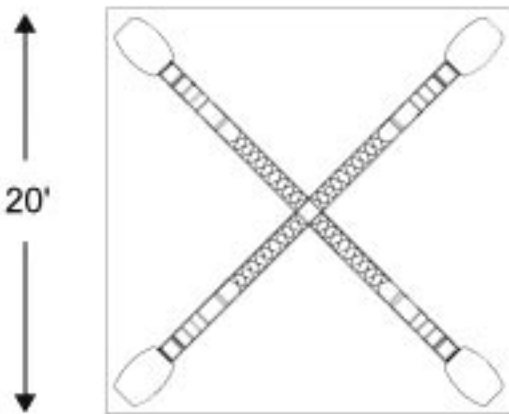

Elevation View

Design - 0052

Approx. Total Wt. = 495#

Shipping Class: 100

Quantity	Part Description	Part Number
4	STOWAWAY BOX STRAIGHT 11.5	SQA1
4	STOWAWAY BOX STRAIGHT 23	SQA2
8	STOWAWAY BOX STRAIGHT 34.5	SQA3
4	STOWAWAY BOX STRAIGHT 46 IN FOR SHELVES	SQA4A
8	STOWAWAY BOX CRV 57.5R 45° V	SQM1
1	STOWAWAY CUBE INT RIG 4WAY	SQX6
12	STOWAWAY SHELF - RECESSED	SAU1
4	STOWAWAY COUNTER TOP KIT	SAU13
8	STOWAWAY ARM LIGHT	SAU31
5	STOWAWAY MOLDED SHIPPING CASE	SAU26





800-457-2369 • 801-409-9036 fax

Miriam inc

Marketing Agency

Design-0053

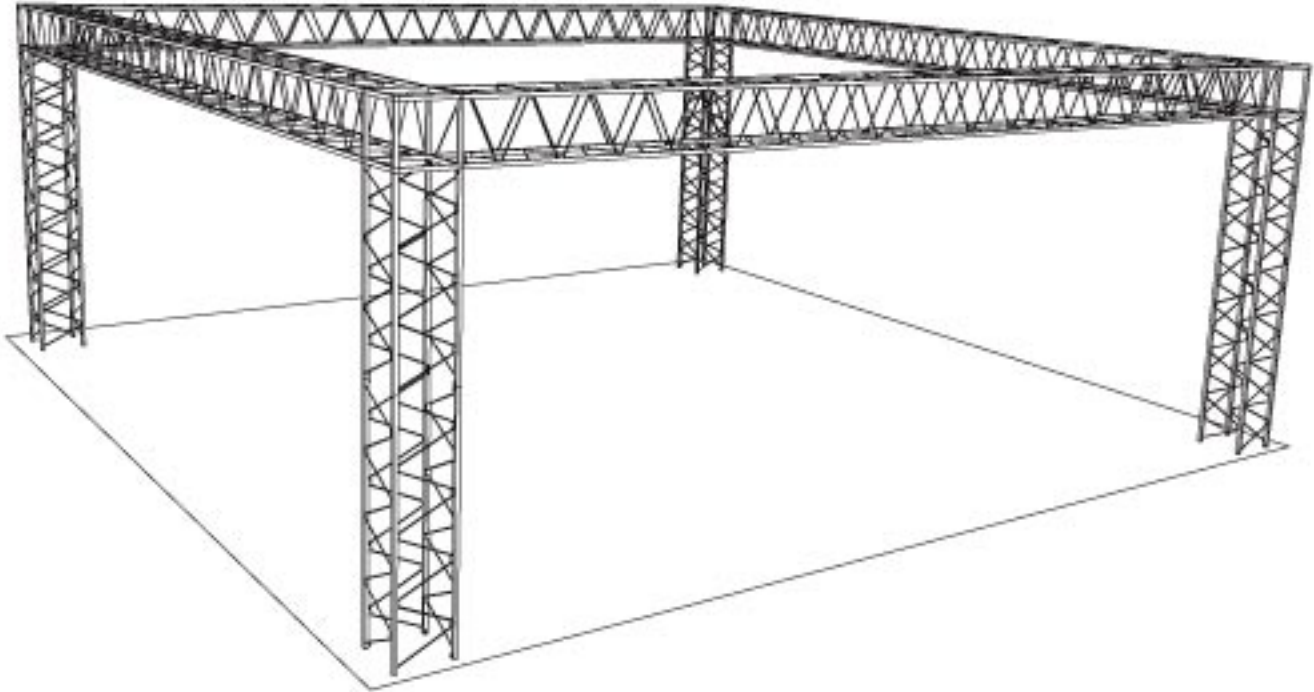

Booth Size: 20' x 20'

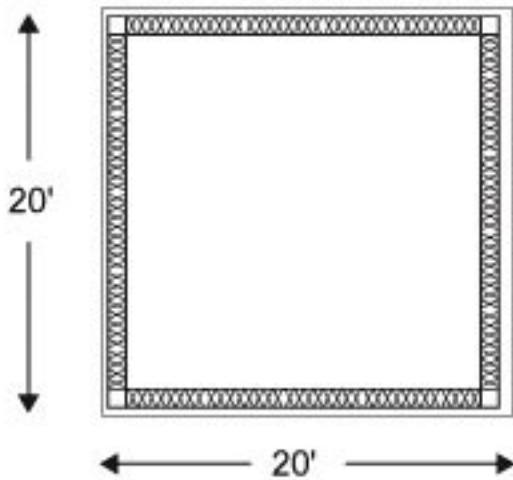

Elevation View

Design - 0053

Approx. Total Wt. = 380#

Shipping Class: 125



Quantity

4
4
20
4
8
5

Part Description

STOWAWAY BOX STRAIGHT 23
STOWAWAY BOX STRAIGHT 34.5
STOWAWAY BOX STRAIGHT 46
STOWAWAY CUBE INT RIGID 90° 3 WAY
STOWAWAY ARM LIGHT
STOWAWAY MOLDED SHIPPING CASE

Part Number

SQA2
SQA3
SQA4
SQX3
SAU31
SAU26